

Lemur-C (Ticket) Specifications



General

Print Method: direct thermal
Print Speed: 8" per sec. maximum
Resolution: 203 dpi (8 dots/mm)
Size: 16,5H x 16,8W x 17,0L cm
 (6.5H x 6.6W x 6.7L inches)
Weight: 1,5 kg (3.4 lbs)

Media Transport

Media Type: fanfolded tickets
Ticket Thickness: .004" to .0075"
Ticket Width: 2.0" to 3.25"
Positioning: optical detector senses black mark at 5" from ticket edge
Ticket Separation: Manual tear-off or optional cutter with hopper (horizontal) or top plate (vertical)

Interfaces

Standard: Serial and USB
Optional: Ethernet, Bluetooth & Wi-Fi

Protocols

Standard: FGL
Drivers: Windows, Mac and Linux

Approvals

Designed to meet: UL / FCC / CE / CCC / ENERGY STAR / RoHS

Power Requirements

100-240 VAC, 50/60Hz, 65W max
 Amp max 24 VDC, 2.5 Amp max

Power Consumption

Standby: 5W
Normal printing: 34W

Environmental

Operating Temperature: -20° to 60°C*
Relative Humidity: 10% to 90%
Storage Temperature: -40 to 70°C above specs without condensation

Bar Codes

Most 1D and 2D codes including PDF417, Datamatrix, QR, Aztec

Full speed printing of picket fence and ladder bar codes

Fonts

Resident fonts: 16 bitmapped fonts (including Cyrillic and German characters) and Asian character set sets (optional)

Downloadable fonts: HP Soft fonts / TrueType fonts

Downloadable RAM: up to 27MB
Downloadable Flash: up to 12MB (optional)

Graphics

FGL format, PCX format (1bit b/w), BMP format (1bit b/w)

Web Interface (ethernet only)

Real-time status monitor
 Email notification

Projected Life

Cutter: 1 million cuts
Print Head: 60 km of paper or 100 million dot activations

Warranty

Printer: 1 year, parts and labor
Print Head: 90 days

Life time print head warranty when using exclusively our tickets

Patents

BOCA has a patented head protection system that prevents premature head failure

Show with Vertical Option

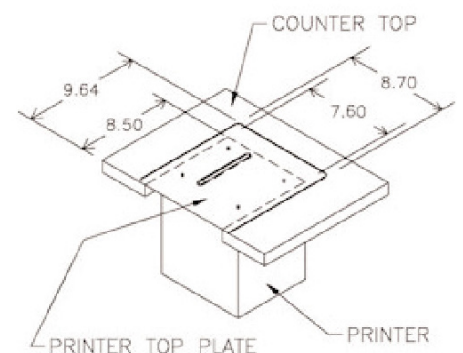

* Print speed may be affected at extreme temperatures